



1	3
2	3
3	4
3.1	4
3.2	4
3.3	5
3.4	7
3.5	8
4	12
4.1	12
4.2	12
5	12
5.1	12
60.5.....	

-
-
-
-
-
-
-
-
-
-

60 , ,

DC AC





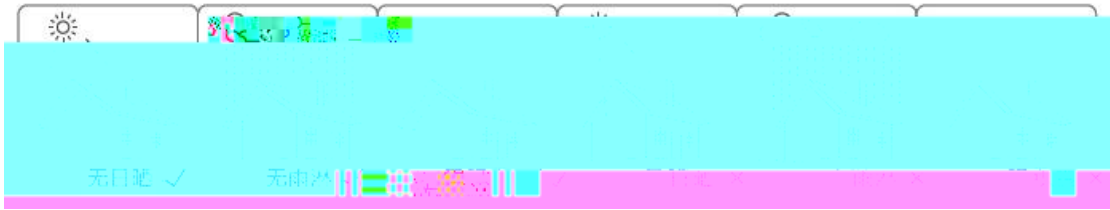

-
-
-
-
-

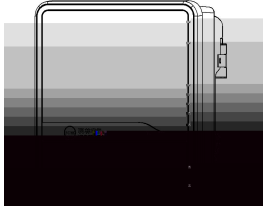

45

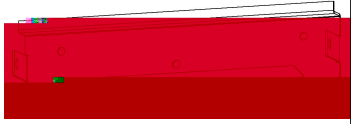

3.2

3.1

(KE-GU3KTL3/5KTL3/6KTL3)			
1		5	
	1		2
2		6	
	1		1
3		7	
	3		1

4		8	
	1		1

3.1

DC

3.1

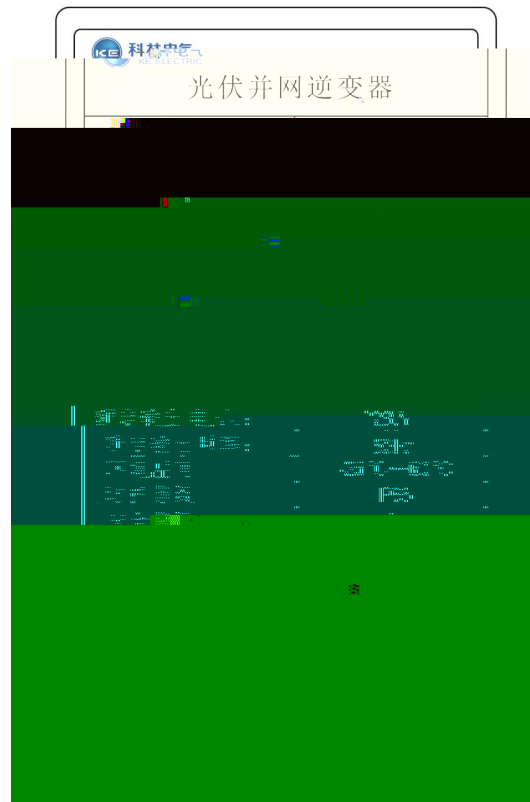

3.1

3.3

-

-

95%

-
-
-
- 3.2

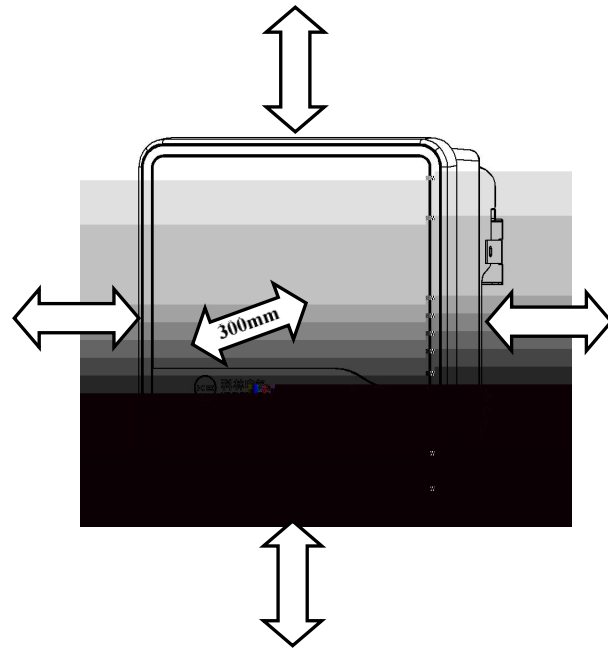

3.2

-
-

3.2

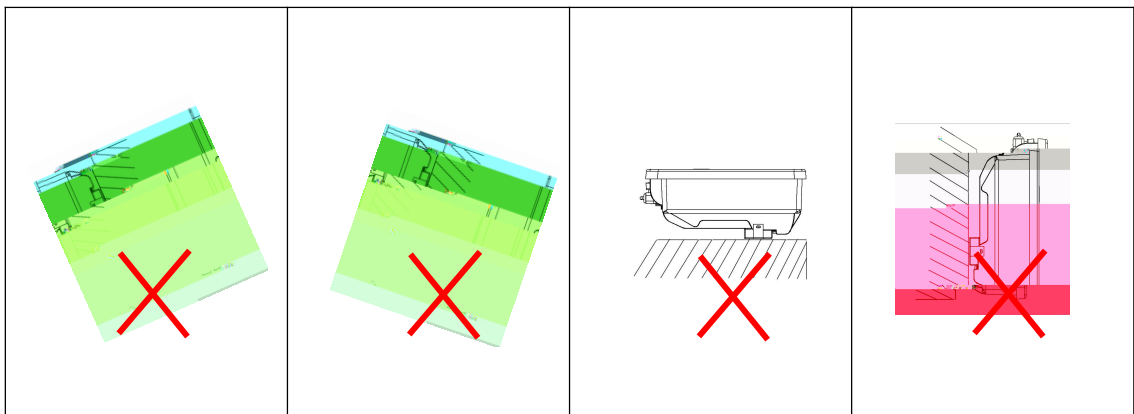



3.2

3.4

- 1
- 2
- 3
- 8mm
- 60mm
- 3.3

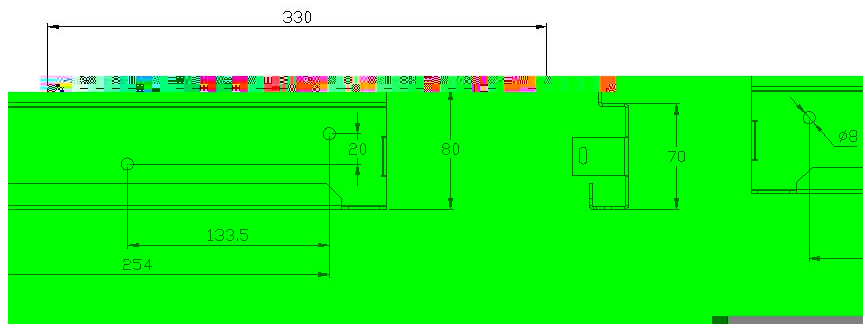

3.3

- 3
- 3.4

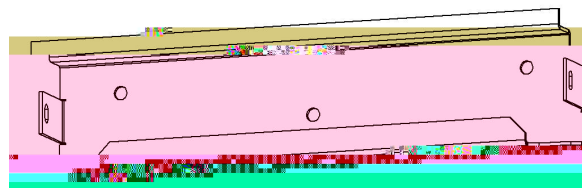

3.4

- 4
- 3.5

5 M4
3.5



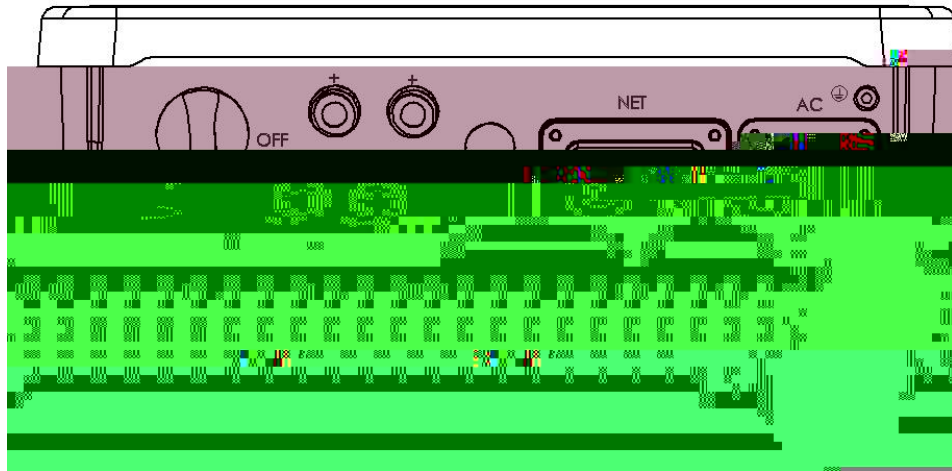

3.6

	mm ²			
	KE-GU3KTL3	KE-GU5KTL3	KE-GU6KTL3	
DC+	2.5	4	4	
DC-	2.5	4	4	
L	2.5	4	4	1
N	2.5	4	4	1
PE	2.5	4	4	1
	0.3	0.3	0.3	2

3.3

- 1
- 180~276V
- 47~52 Hz
- AC L, N PE
- 2 PE 10
- 3
- 4
- 10mm

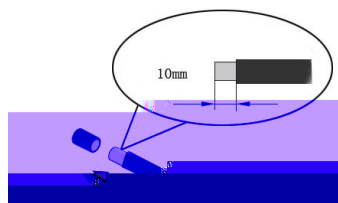

3.7

- 3.8

L N PE

-

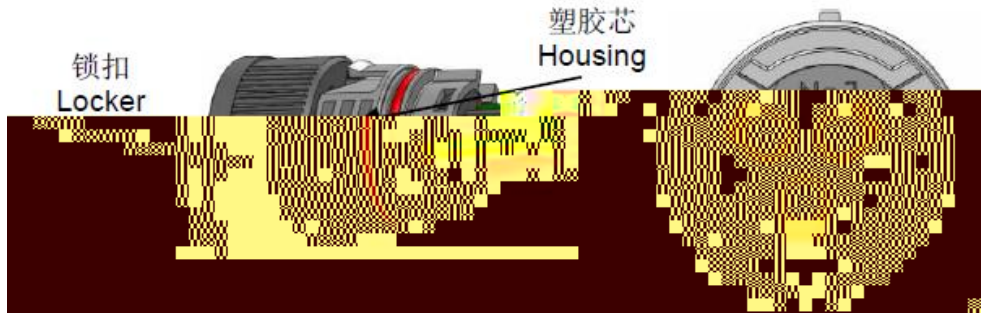

3.8

-

MC4

3.3

-

3.9

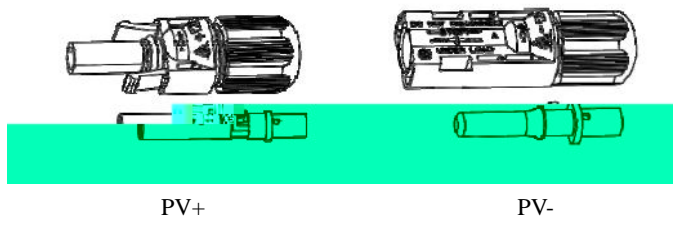

3.9

-



3.10

-

3.11



3.11

-

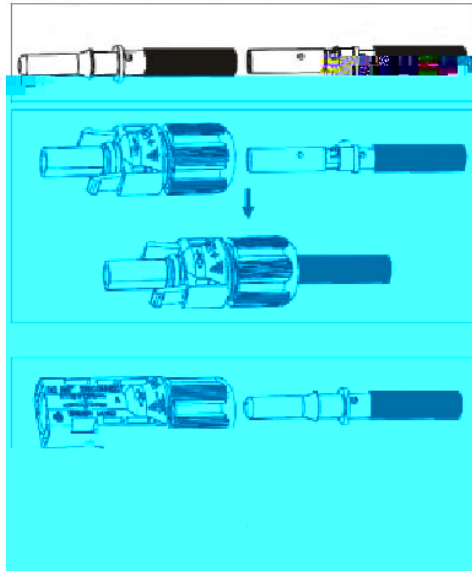

3.12

-

2.6~2.9 m

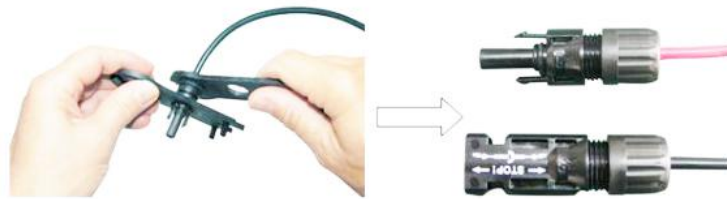

3.13

-

3.6

RS485

-

RS485

A B

-

RS485

120

GPRS

- GPRS

APP



-
-
-
-
-
-
-
-
-

DC

DC

AC

AC

AC

-
-

AC

1-2

2



1.



5.1

1

5.1

LED

APP

-

-



APP

7.1

	1 2 3
	1 2
	1 2
	1 2 3
	1 2 3
	1 2

80



	3
	1 2
	1 2 3

7.1

		KE-GU3KTL3	KE-GU5KTL3	KE-GU6KTL3
DC		550V		
		135V		
	MPPT	120V-550V		
		4kW	6.5kW	7kW
		12A	22A	
	MPPT / MPPT	1/1	1/2 2/1	2/1
AC		3kW	5kW	6kW
		14A	23A	27A
		230Vac()		
		180V~276V		
		50Hz		
		47Hz~52Hz		
		0.95()~0.95()		
		<2%		
		<0.5%		
		98.08%		
		97.5%	97.5%	97.5%
		IP65		
		-25 ~60		
		0~95%		
		4000m(>2000m)		
	* *	372mm*408mm*155mm		
	Kg	14kg	15kg	16kg
		RS485/WIFI/GPRS		

GPRS

485 WIFI







http://www.solarke.com/SolarKE_Monitor

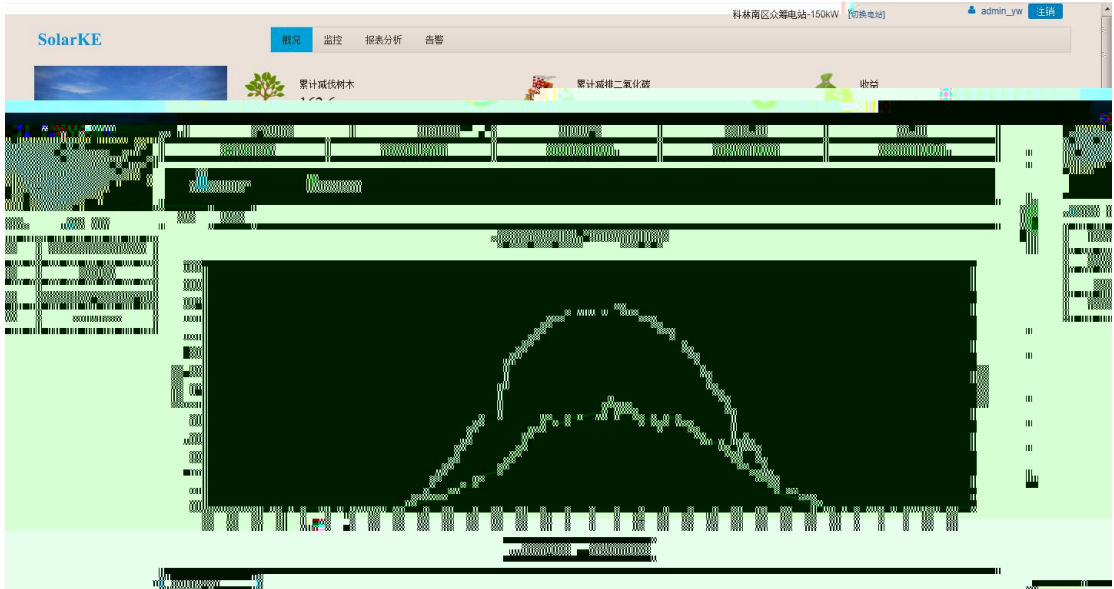
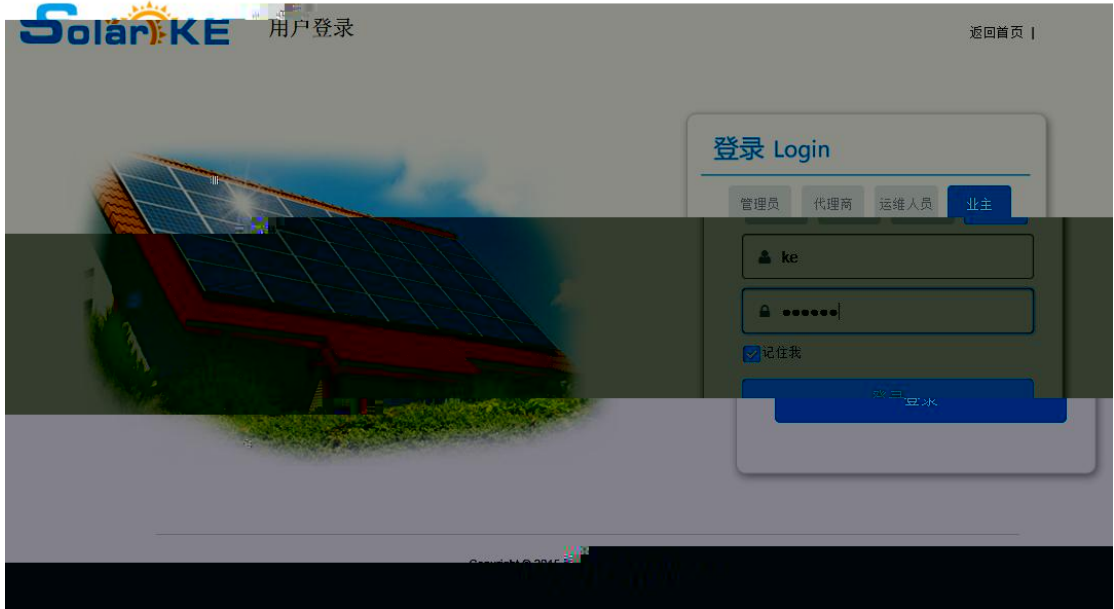



-
-

5

-
-
-
-
-
-
-
-
-
-
-
-

-

-
-
-
-
-
-

-
-

- 0086-311-85231078 400-0311-128
- 0086-311-85231087
- 050222
- <http://www.kechina.com>